

## ACTIVITIES IN LIQUID Ga–Te ALLOYS AT 1120 K

S. SRIKANTH and K.T. JACOB \*

*Department of Metallurgy, Indian Institute of Science, Bangalore 560 012 (India)*

(Received 8 February 1989)

### ABSTRACT

The activity of gallium in liquid Ga–Te alloys has been measured at 1120 K using a solid state galvanic cell incorporating yttria-stabilized thoria as the solid electrolyte. The cell can be schematically represented as

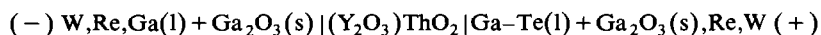

The activity of tellurium was derived by Gibbs–Duhem integration. The activity of gallium shows negative deviation from Raoult's law for  $X_{\text{Ga}} < 0.6$  and positive deviation from ideality for  $X_{\text{Ga}} > 0.6$ . The activity of gallium was constant in the composition range  $0.73 < X_{\text{Ga}} < 0.89$ , indicating liquid state immiscibility in this region. The Gibbs energy of mixing and the concentration–concentration structure factor at long wavelength limit show a minimum at  $X_{\text{Ga}} \approx 0.4$ , suggesting strong interactions in the liquid phase with formation of 'Ga<sub>2</sub>Te<sub>3</sub>'-type complexes.

### INTRODUCTION

Liquid Ga–Te alloys are semi-conducting in nature and their electronic properties are very similar to those of typical solid semi-conductors [1]. Since molecular structure is of key importance in liquid semi-conductors, the thermodynamic study of Group III–IV alloys is particularly relevant to liquid semi-conductors. Thermodynamic data provide a powerful means of inferring the existence of compounds in binary alloys and are therefore a potential source of information about structure. Though diffraction studies represent, in principle, the most direct method of obtaining structural information about liquid alloys, relatively little of this work has been done with liquid semi-conductors because of the difficulties associated with inferring three-dimensional structural information from structure factor data.

The electronegativities of Ga and Te are widely different (0.7 on the Pauling scale [2]) and hence one can expect strong associations in liquid

\* Author to whom correspondence should be addressed.

Ga–Te alloys. According to Elliott [3], there are two congruently melting compounds in the Ga–Te phase diagram, GaTe ( $T_m = 1108$  K) and  $\text{Ga}_2\text{Te}_3$  ( $T_m = 1065$  K), and two incongruently melting compounds,  $\text{Ga}_3\text{Te}_2$  and  $\text{GaTe}_3$ . Furthermore, there is a liquid miscibility gap on the Ga-rich side.

There are very few thermodynamic studies in the literature on Ga–Te alloys. For solid alloys, only the molar enthalpies and entropies of formation of the two congruently melting compounds are known [4]. For the liquid state, Castanet and co-workers [5,6] have measured the molar enthalpy of formation of Ga–Te alloys over the entire concentration range at different temperatures by direct reaction calorimetry using a Calvet microcalorimeter. They report large negative values for the enthalpies of formation with a minimum at  $X_{\text{Ga}} \approx 0.4$ , suggesting the presence of ‘ $\text{Ga}_2\text{Te}_3$ ’-type associates in the liquid. Their results do not indicate any temperature dependence for the enthalpy of mixing in liquid alloys. Predel et al. [7] have determined by vapour pressure measurements the activity of Te at 1114 K over the whole range of composition, and have used these values to calculate the activity of Ga. The activity of Te reported in their study shows large negative deviations from ideality. However, their results are associated with a large scatter. EMF measurements employing solid electrolytes can yield more precise results than vapour pressure studies. Katayama et al. [8] have measured the activity of Ga in liquid Ga–Te alloys in the temperature range 931–1180 K by an EMF method employing calcia-stabilized zirconia as the solid electrolyte. Their study shows that the activity of Ga at 1123 K exhibits large negative deviation from Raoult’s law on the Te-rich side, and a transition from negative to positive deviation from ideality in the intermediate concentration range.

In the present study, the activity of Ga in liquid Ga–Te alloys has been measured at 1120 K using a solid state galvanic cell incorporating yttria-doped thoria as the solid electrolyte. It was decided to use a thoria-based solid electrolyte because the low oxygen pressure limit for the onset of electronic conduction in this material is several orders of magnitude lower than for stabilized zirconia. The oxygen potential corresponding to the coexistence of Ga and  $\text{Ga}_2\text{O}_3$  is close to the boundary of the electrolytic conduction domain of doped zirconia.

## EXPERIMENTAL

### *Materials*

Semi-conductor grade elemental gallium and tellurium were obtained from Johnson Matthey Chemicals. Gallium sesquioxide ( $\text{Ga}_2\text{O}_3$ ) of 99.999% purity was obtained from Alfa Products. The alloys were made by melting in situ. The composition of the alloys was confirmed by chemical analysis at

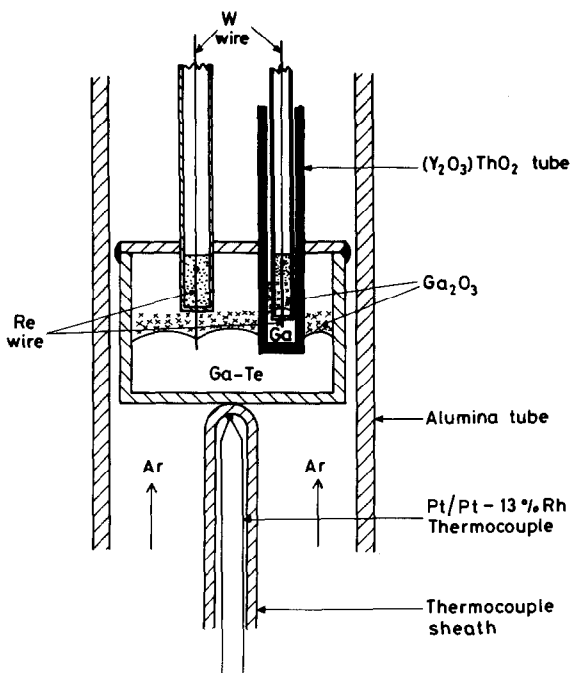
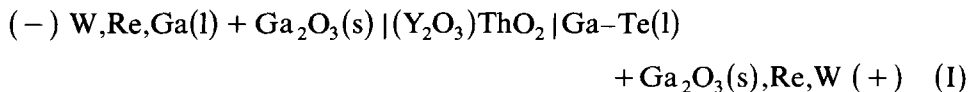

Fig. 1. Schematic diagram of the cell arrangement.

the end of each run. The experimental cell housing was constructed entirely of high purity recrystallized alumina. High purity argon gas, dried and deoxidized by passing over anhydrous magnesium perchlorate, copper at 675 K and titanium at 1150 K, was used as an inert atmosphere in the cell.

### *Experimental apparatus and procedure*

A schematic diagram of the experimental apparatus is shown in Fig. 1. In this study, the activity of Ga(l) was determined directly, as a function of composition, using a galvanic cell with yttria-stabilized thoria solid electrolyte and a Ga + Ga<sub>2</sub>O<sub>3</sub> two-phase mixture as the reference electrode. The cell can be schematically represented by



The alloy electrode saturated with Ga<sub>2</sub>O<sub>3</sub> was contained in an alumina crucible. The solid electrolyte tube containing the reference electrode was placed in contact with the alloy + Ga<sub>2</sub>O<sub>3</sub> mixture. The reference electrode consisted of pure liquid Ga covered with gallium sesquioxide. The space above the reference electrode in the electrolyte tube was closed by a tight-fitting alumina disc supported on an alumina tube carrying the tung-

sten lead. Electrical contact with the alloy and the reference electrodes was made using rhenium wires spot-welded to tungsten-lead wires. The cell was suspended in a Kanthal wound vertical resistance furnace inside an outer alumina tube. Prepurified argon gas was passed through the outer alumina tube at a rate of  $4 \text{ ml s}^{-1}$ . The temperature was controlled to within  $\pm 1 \text{ K}$ . The temperature was monitored using a Pt/Pt-13%Rh thermocouple placed in contact with the bottom of the alumina crucible. The EMF of the cell was measured using a Keithley digital millivoltmeter with an impedance exceeding  $10^{12} \Omega$ . The compositions of the alloys were determined by chemical analysis after each run. The EMF attained a steady value within a short time ( $\sim 0.6 \text{ ks}$ ) of the cell reaching thermal equilibrium. The EMF values remained constant ( $\pm 0.1 \text{ mV}$ ) for periods in excess of 4 ks. The reversibility of the cell was tested by passing small currents ( $\sim 50 \mu\text{A}$  for 0.2 ks) through the cell in both directions. It was found that after each titration the EMF returned rapidly to the steady value observed before the titration. The EMF was also insensitive to the flow rate of argon gas through the cell in the range  $2.5\text{--}8 \text{ ml s}^{-1}$ .

## RESULTS AND DISCUSSION

The EMF values for cell I at 1120 K, measured as a function of composition of Ga, are summarized in Table 1 and plotted as a function of concentration in Fig. 2. The activity of Ga was calculated from the measured EMF  $E$  (mV) using the relation

$$\ln a_{\text{Ga}(\text{alloy})} = -3EF/RT \quad (1)$$

TABLE 1

Values of EMF, activity and free energy of mixing for liquid Ga-Te alloys at 1120 K

$X_{\text{Ga}}$	$E$ (mV)	$a_{\text{Ga}}$	$a_{\text{Te}}$	$\Delta G^{\text{m}}$ (kJ mol $^{-1}$ )
0.045	262.90	$2.82 \times 10^{-4}$	0.957	-3.815
0.120	238.40	$6.03 \times 10^{-4}$	0.911	-9.046
0.210	211.80	$1.38 \times 10^{-3}$	0.748	-15.018
0.300	182.90	$3.39 \times 10^{-3}$	0.563	-19.627
0.390	131.00	$1.70 \times 10^{-2}$	0.237	-22.979
0.440	83.70	$7.41 \times 10^{-2}$	$8.17 \times 10^{-2}$	-23.726
0.520	34.60	0.341	$2.02 \times 10^{-2}$	-22.650
0.610	14.50	0.638	$9.09 \times 10^{-3}$	-19.623
0.680	5.92	0.832	$5.65 \times 10^{-3}$	-16.588
0.720	3.42	0.899	$4.72 \times 10^{-3}$	-14.678
0.780	3.03	0.910	$4.63 \times 10^{-3}$	-11.699
0.870	3.03	0.910	$4.63 \times 10^{-3}$	-7.272
0.950	1.65	0.950	$2.66 \times 10^{-3}$	-3.214

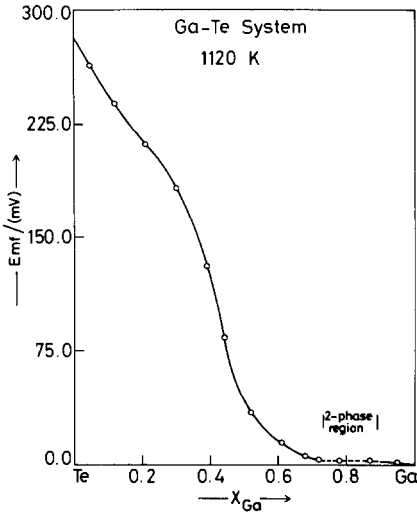

Fig. 2. Variation of EMF with composition for liquid Ga-Te alloys at 1120 K.

where  $F$  is the Faraday constant,  $R$  is the gas constant and  $T$  is the absolute temperature. The calculated activities are shown in Table 1 and plotted as a function of concentration in Fig. 3. From the activity-composition plot it can be seen that the activity of Ga remains constant in the mole fraction range  $0.733 < X_{\text{Ga}} < 0.89$ , indicating liquid state immiscibility in this region. From the activity coefficients of Ga in the Ga-Te liquid alloy, the activity coefficients of Te(l) at 1120 K were derived by Gibbs-Duhem

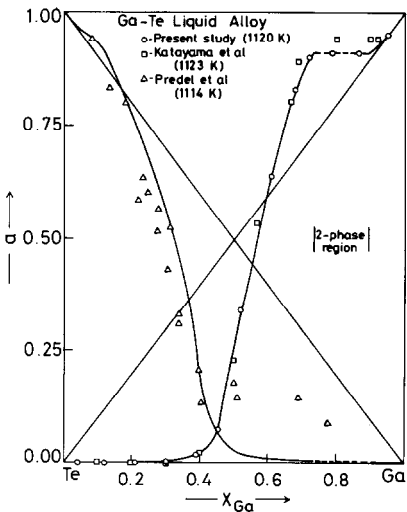

Fig. 3. Composition dependence of activities in liquid Ga-Te alloys at 1120 K.

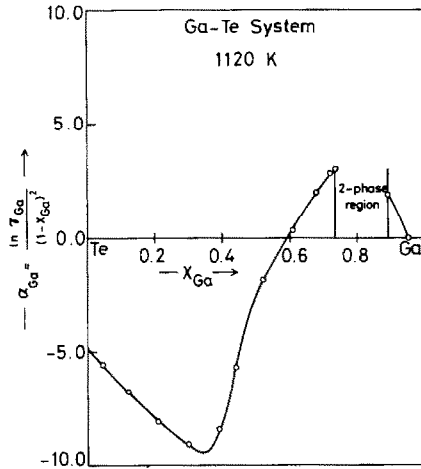

Fig. 4. Variation of the  $\alpha$ -function with composition for liquid Ga-Te alloys at 1120 K.

integration using the  $\alpha$ -function for  $0.27 < X_{\text{Te}} < 1.00$

$$\ln \gamma_{\text{Te}} = -\alpha_{\text{Ga}} X_{\text{Ga}} X_{\text{Te}} - \int_{X_{\text{Te}}=1}^{X_{\text{Te}}} \alpha_{\text{Ga}} dX_{\text{Te}} \quad [0.27 < X_{\text{Te}} < 1.00] \quad (2)$$

The variation of the function  $\alpha_{\text{Ga}} = \ln \gamma_{\text{Ga}} / (1 - X_{\text{Ga}})^2$  as a function of  $X_{\text{Ga}}$  at 1120 K is shown in Fig. 4. The activities in the two-phase region are constant. Activities of Te at low concentrations of Te ( $0.0 < X_{\text{Te}} < 0.11$ ) were derived by integrating the  $\alpha$ -function between a chosen composition and the boundary of the miscibility gap

$$[\ln \gamma_{\text{Te}} + \alpha_{\text{Ga}} X_{\text{Ga}} X_{\text{Te}}]_{X_{\text{Te}}=0.11}^{X_{\text{Te}}} = - \int_{X_{\text{Te}}=0.11}^{X_{\text{Te}}} \alpha_{\text{Ga}} dX_{\text{Te}} \quad (3)$$

The calculated activities of Te as a function of composition are tabulated in Table 1 and plotted in Fig. 3. The activity of Ga shows negative deviation from Raoult's law for  $X_{\text{Ga}} < 0.6$  and positive deviation from ideality for  $X_{\text{Ga}} > 0.6$ . The activity of Te shows mild positive deviation up to  $X_{\text{Ga}} = 0.17$  and large negative deviation at higher concentrations. The concentration-concentration structure factor of Bhatia and Thornton at zero wave vector [ $S_{\text{cc}}(0)$ ] can be evaluated from the activity data using

$$S_{\text{cc}}(0) = (1 - X_{\text{Ga}}) \left[ \frac{\partial \ln a_{\text{Ga}}}{\partial X_{\text{Ga}}} \right]_{T,P}^{-1} \quad (4)$$

Values for  $S_{\text{cc}}(0)$  derived from the experimental activity data using a numerical differentiation procedure are shown in Fig. 5 as a function of composition. The  $S_{\text{cc}}(0)$  plot shows a minimum at  $X_{\text{Ga}} \approx 0.4$ , suggesting the presence of 'Ga<sub>2</sub>Te<sub>3</sub>'-type complexes in the liquid state. The structure factor is related to the mean square thermal fluctuation in composition

$$S_{\text{cc}}(0) = \bar{N} \langle (\Delta c)^2 \rangle \quad (5)$$

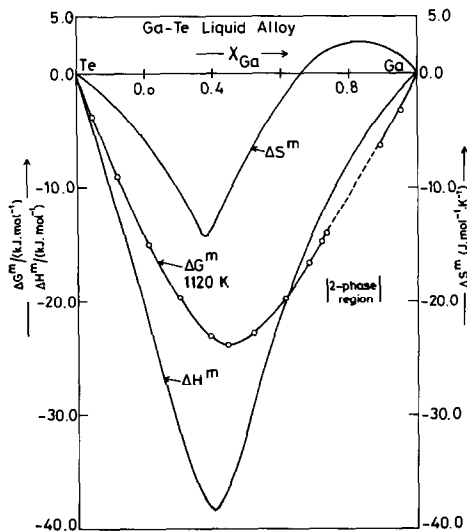

Fig. 5. Integral Gibbs energies of mixing at 1120 K, and enthalpies and entropies for liquid Ga-Te alloys.

where  $\bar{N}$  is the average number of particles in a fixed volume  $V$ , and  $(\Delta c)^2$  is the mean square thermal fluctuation in concentration. The integral molar free energy of mixing  $\Delta G^m$  ( $\text{kJ mol}^{-1}$ ) calculated at 1120 K using the expression

$$\Delta G^m = RT(X_{\text{Ga}} \ln a_{\text{Ga}} + X_{\text{Te}} \ln a_{\text{Te}}) \quad (6)$$

is shown in Fig. 6 as a function of concentration, and values are given in Table 1. The Gibbs energy of mixing shows a minimum at  $X_{\text{Ga}} \approx 0.4$ .

Castanet and co-workers [5,6] have measured the molar enthalpy of formation of liquid Ga-Te alloys over the whole concentration range 1123–1238 K by direct reaction calorimetry using a Calvet microcalorimeter. Their studies do not indicate any temperature dependence of mixing enthalpy in liquid alloys. The enthalpy of mixing reported in their study at 1123 K is shown in Fig. 6 as a function of concentration. The results of the present study can be combined with the calorimetric measurements of Said and Castanet [6] to derive the entropy of mixing for liquid Ga-Te alloys. The entropy of mixing evaluated as a function of concentration is sketched in Fig. 6. The entropy of mixing is negative up to  $X_{\text{Ga}} \approx 0.67$  with a minimum at  $X_{\text{Ga}} \approx 0.4$ , substantiating the presence of 'Ga<sub>2</sub>Te<sub>3</sub>'-type complexes in the liquid.

Katayama et al. [8] have measured the activity of Ga in liquid Ga-Te alloys in the temperature range 931–1180 K by an EMF method employing calcia-stabilized zirconia as the solid electrolyte. The activity data reported in their study at 1123 K are shown in Fig. 3 for comparison. Their results are in reasonable agreement with those obtained in the present study, except

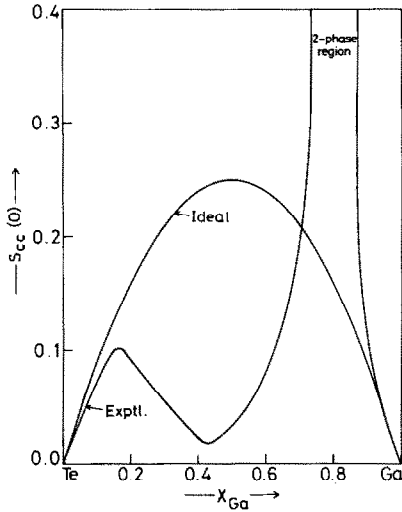

Fig. 6. Concentration-concentration structure factor at zero wave vector [ $S_{cc}(0)$ ] for liquid Ga-Te alloys at 1120 K.

at high Ga concentrations. It is possible that their measurements have been affected by a small degree of electronic conduction in their stabilized-zirconia solid electrolyte. Predel et al. [7] have determined the activity of Te at 1114 K over the entire concentration range using an isopiestic technique. Their results are also shown in Fig. 3. The activity data they report agree within the limits of experimental error with the activity of Te derived in the present study for Te-rich compositions. At low concentrations of Te, the activity values reported in their study are significantly higher than those derived in the present study. The gas pressure over pure Te is predominantly dimeric. Predel et al. [7] calculated the activity using the expression

$$a_{\text{Te}} = \left( \frac{p_{\text{Te}}}{p_{\text{Te}}^{\ominus}} \right)^{1/2} \quad (7)$$

where  $p_{\text{Te}}$  is the partial pressure of the dimeric species over the alloy, and  $p_{\text{Te}}^{\ominus}$  is the corresponding pressure over pure Te. However, when the activity of Te is low, the relative concentration of the monomeric species will increase by virtue of the equilibrium



$$K = \left( \frac{p_{\text{Te}_2}}{p_{\text{Te}} a_{\text{Te}}} \right) \quad (9)$$

The change in the monomeric/dimeric ratio in the gas phase with alloy composition does not appear to have been considered by Predel et al. in the evaluation of their isopiestic data.



## REFERENCES

- 1 M. Cutler, *Liquid Semiconductors*, Academic Press, New York, 1977.
- 2 L. Pauling, *The Nature of the Chemical Bond*, Cornell University Press, Ithaca, 1960.
- 3 R.P. Elliott, *Constitution of Binary Alloys*, McGraw-Hill, London, 1965.
- 4 K.C. Mills, *Thermodynamic Data for Inorganic Sulphides, Selenides and Tellurides*, Butterworths, London, 1974.
- 5 R. Castanet and C. Bergman, *J. Chem. Thermodyn.*, 9 (1977) 1127.
- 6 H. Said and R. Castanet, *J. Less-Common Met.*, 68 (1979) 213.
- 7 B. Predel, J. Piehl and M.J. Pool, *Z. Metallkde.*, 66 (1975) 268.
- 8 I. Katayama, J. Nakayama, T. Nakai and Z. Kozuka, *Trans. Jpn. Inst. Met.*, 28 (1987) 129.